

Design. Uniqueness. Innovations

Technical support



Thank you for
choosing our equipment

SLINEX

Design. Uniqueness. Innovations

SQ-04M

4" video intercom

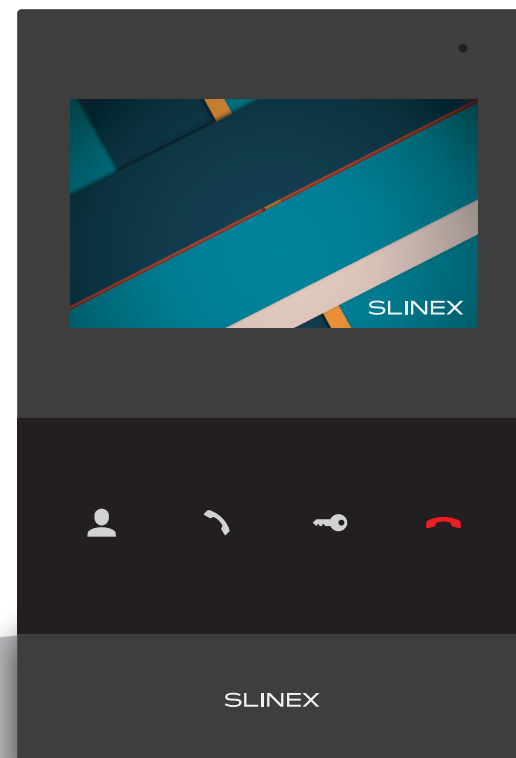

User manual

SLINEX

Attention!



As a result of continuous upgrades and functionality improvements, technical characteristics of the device can be changed without any preliminary declaration. This manual can contain some inaccuracy or misprint. The owner reserves the right to make corrections to the information described in the user manual and device package. The last revision of this manual is available on www.slinex.com

Safety instructions

- Read and keep that manual.
- The device installation process should be carried out by the qualified specialists.
- Use the device from -10 °C to +55 °C, always keep it within that temperature range.
- Installation surface should be free from vibration and impact influence.
- Keep this device far from open sources of heat, such as radiators, heaters, and ovens.
- The device can be installed near other electronic equipment in case if the temperature of the environment does not exceed previously mentioned range.
- The device should be protected from the direct influence of the natural phenomena, such as direct sunlight, rain or snow.
- Don't use aggressive or abradant detergent for the device surface cleaning.
- Use soft wet cloth or tissue to remove strong dirt.
- Don't overpower outlets. It can cause fire or electric shock.

Nature protection



Don't throw away the device with other industrial or nutritive trash if you see that symbol. Some regions have separation and recycling systems for the electronic equipment. Connect with local authorities to receive information about recycling of electronic equipment for your region.

Rights and limitation of liability

All rights reserved. Any part of that document can not be published in any form, translated into other languages or reproduced in any way including electronic or mechanical. Document recording and copying is strictly denied without owner permission.

Table of contents

1. Package	3
2. Specification	3
3. Description	4
4. Installation	5
4.1. Cable requirements	5
4.2. Schematic diagrams	6
4.3. Unit mount	8
5. Operation	9
5.1. Incoming call	9
5.2. Outdoor panel and camera monitoring	10
5.3. Incoming call redirection	11
5.4. Intercom	12
6. Settings	12
6.1. Main menu	13
6.2. System settings	13
6.3. Ring settings	15
6.4. Working mode settings	16
6.5. Alarm settings	17
6.6. Image parameters setting	20
6.7. Snapshots and records playback	21
7. Manual and automatic recording	23
8. Hardware motion detection recording	23
9. Limited Warranty	24

1. Package

SQ-04M indoor monitor – 1 pc.
 Wall mounting bracket – 1 pc.
 Connection wires – 1 pkg.
 Mounting screws and nuts – 1 pkg.
 User manual – 1 pc.

2. Specification

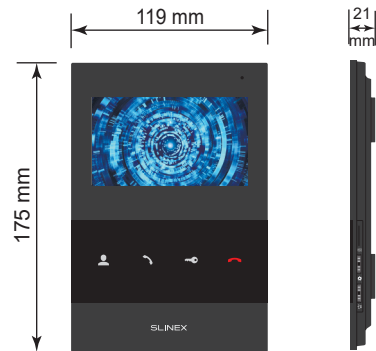

SCREEN 4.3", color TFT	STANDBY MODE POWER CONSUMPTION 1 W
RESOLUTION 480x272 px.	WORKING MODE POWER CONSUMPTION 6 W
VIDEO SYSTEM PAL / NTSC	POWER SUPPLY Built-in power supply, ~100–240 V
AUDIO TYPE Half duplex	MOUNTING TYPE Surface mount
CALL DURATION 120 seconds	DIMENSIONS 175x119x21 mm (6.89x4.68x0.83")
MEMORY MicroSD card, up to 32 GB Internal memory, up to 100 snapshots	WORKING TEMPERATURE -10 ... +55 °C (+14...+131 °F)

3. Description

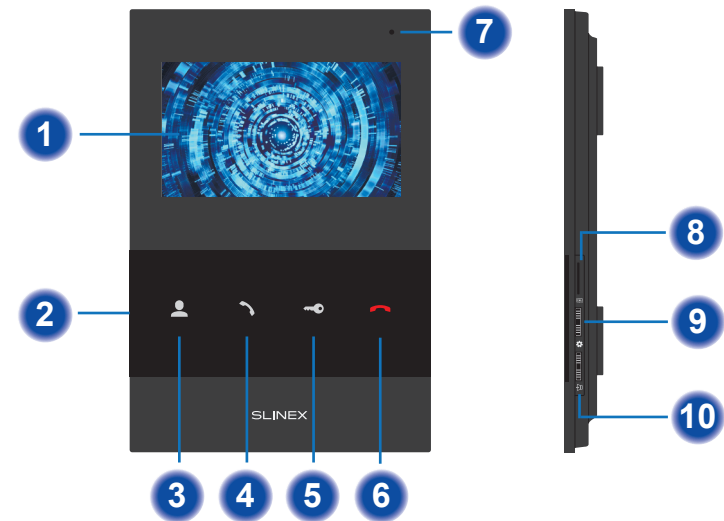

- 1 Display
- 2 Power switch
- 3 «Monitor» button – door panel or camera image monitoring
- 4 «Answer» button – incoming call answer and start talking with the visitor
- 5 «Unlock» button – door unlocking
- 6 «Hang Up» – stop conversation with the visitor / settings menu exit
- 7 Microphone
- 8 microSD card slot;
- 9 Settings joystick:
 - push the joystick while monitoring to save a photo (or video) depends on monitor settings;
 - push the joystick in standby mode to enter settings menu;
 - move joystick up or down to move through the settings menu (next/previous parameter);
 - push the joystick on any parameter to change its value. Change the value of the current parameter by moving joystick up or down and then push the joystick again to save the parameter;
- 10 Volume joystick:
 - move joystick up or down during conversation to increase or decrease talking volume;

4. Installation

4.1. Cable requirements

Disconnect all power cables before device installation.

Cable type that is used for device connection depends on the distance between the last indoor monitor in the system and outdoor panel:

a) Use 4-wire cable with such parameters:

- distance up to 25 meters (82 ft.) use a cable with 0,22 mm² square of one wire (AWG 24);
- distance 25 to 50 (82-164 ft.) meters use a cable with 0,41 mm² square of one wire (AWG 21);
- distance 50 to 100 meters (164-328 ft.) use a cable with 0,75 mm² square of one wire (AWG 18).

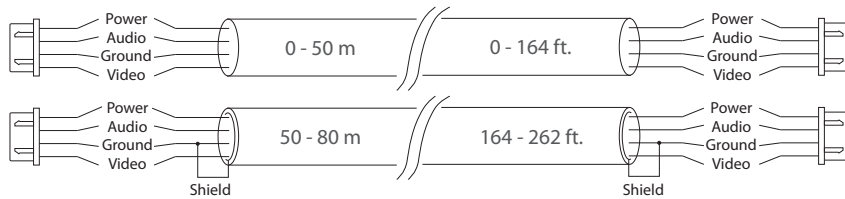

b) If the distance between door monitor and door panel is between 80 and 100 meters (262-328 ft.) then use a 3-wire cable with 0,75 mm² (AWG 18) square of one wire and RG-59 or RG-6 coaxial cable for the video signal.

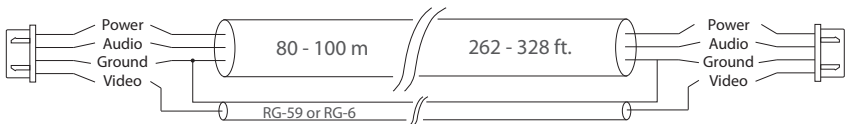

c) Shielded or non-shielded twisted pair (not recommended):

- distance up to 25 meters (82 ft.) non-shielded twisted pair can be used;

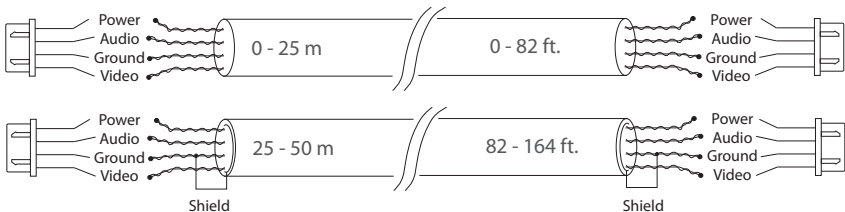

4.2. Schematic diagrams

Diagram 1. SQ-04M door panels, cameras, locks and TV connection.

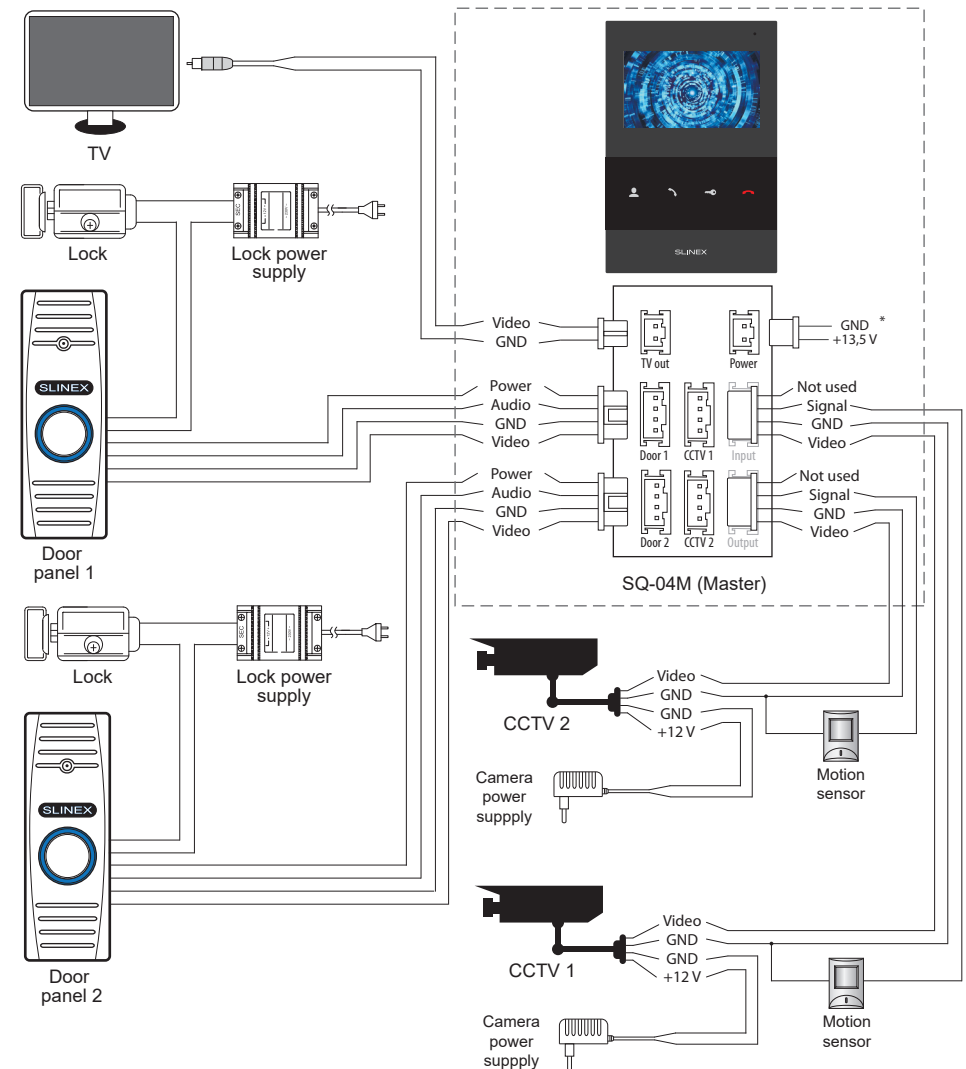
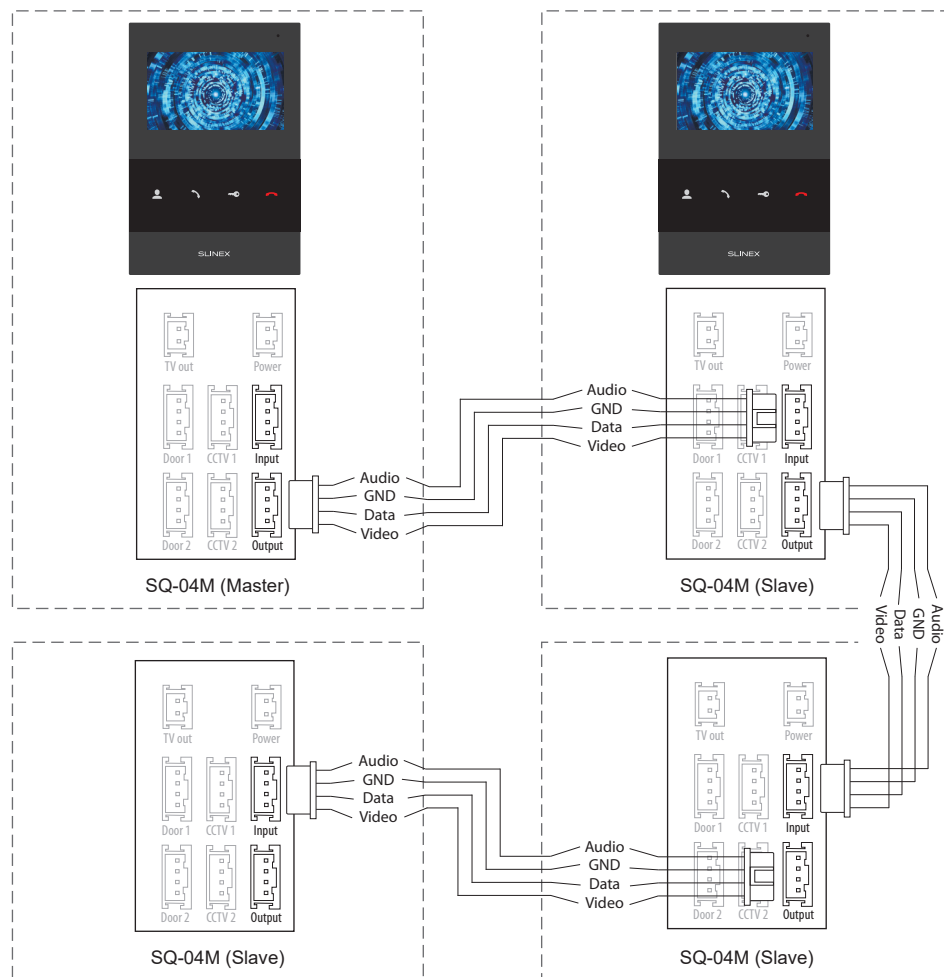

Diagram 2. SQ-04M system connection.



Notes:

* Use «Power» plug on the monitor to connect external power supply +13,5 V. While use external power supply please keep main power cord ~100-240 V disconnected from the outlet, otherwise it can damage monitor circuits.

** Door panels, cameras, power supplies, locks and motion sensors described on the schemes are optional devices and aren't included into monitors kit.

4.3. Unit mount

- 1) Take the surface mount bracket from the kit and situate it 150-160 cm from the floor line.
- 2) Mark and drill four holes in the wall.
- 3) Take four nuts from the kit and hammer them into the drilled holes.
- 4) Fix surface mount bracket on the wall by four screws from the kit.
- 5) Connect all communication wires and fix the monitor on the surface mount bracket.

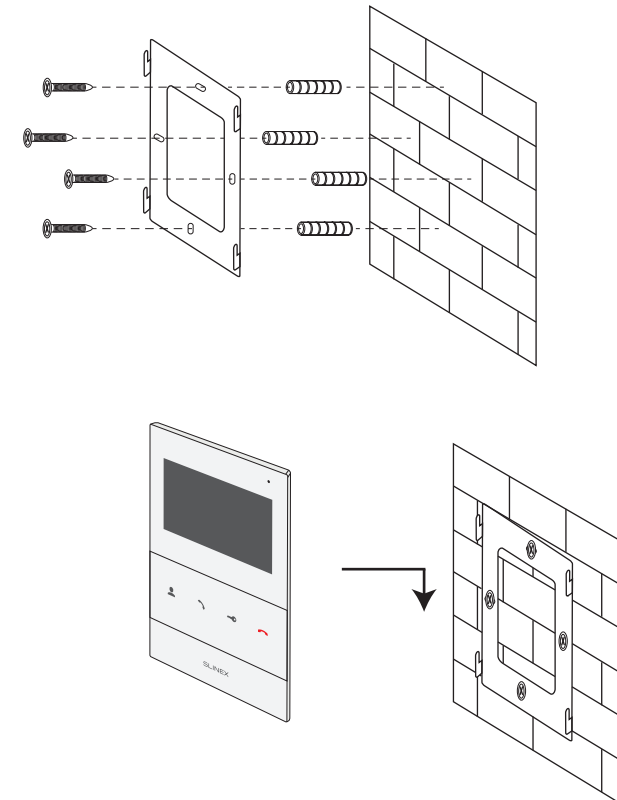

5. Operation

5.1. Incoming call

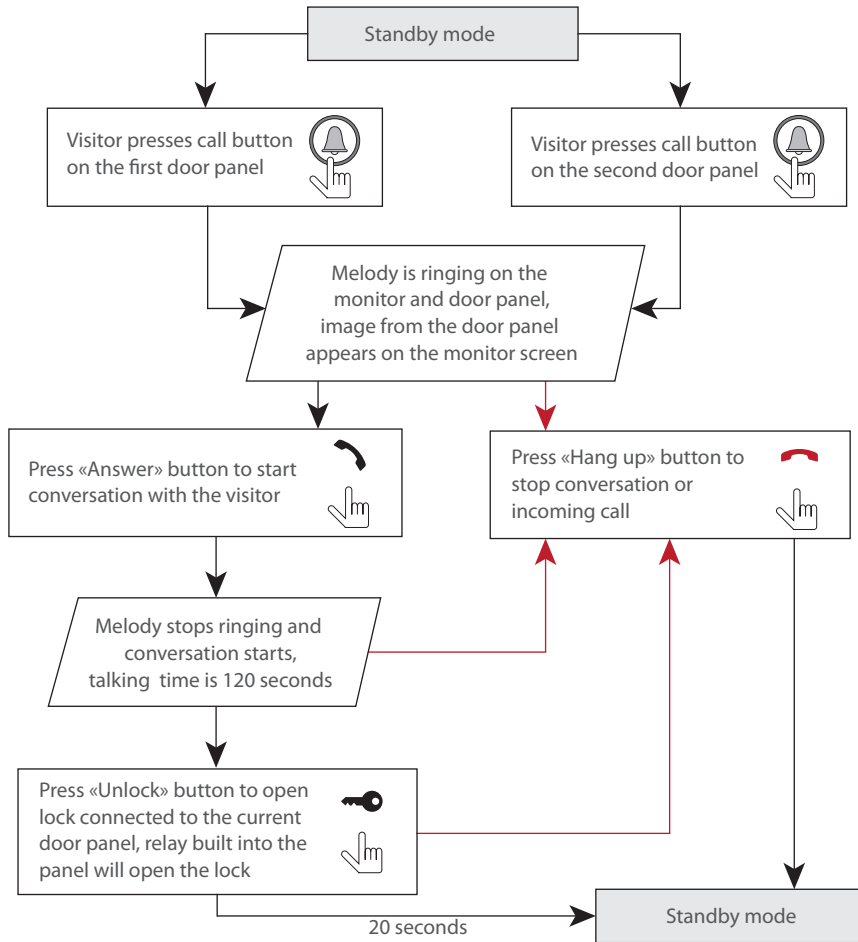

- Notes:
- 1) Monitor will be automatically switched into standby mode if the user doesn't answer incoming call during 60 seconds;
 - 2) Image and sound from the door panel will be active during 20 seconds after the moment user presses button. It let the user know if the visitor passed through the door.

5.2. Door panel and camera image view

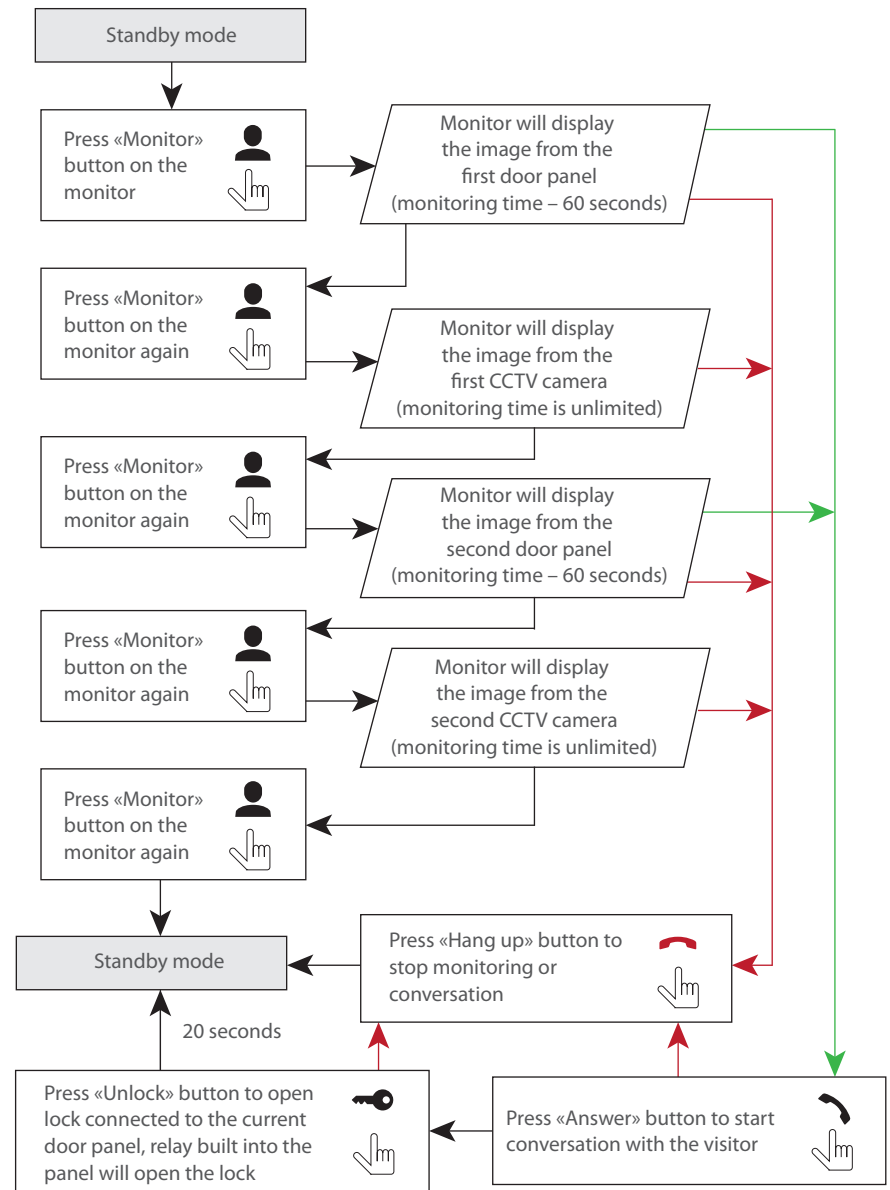

Notes:

- 1) If several monitors are connected into one system, user can view the image from the outdoor panels and cameras on any monitor inside this system. The image will be transferred from the «Master» monitor outdoor panels and cameras to the «Slave» monitors.
- 2) If someone press call button on the door panel while monitoring is active then the image from this outdoor panel appears on the monitor screen and call melody starts. Press «Answer» button to start conversation.

5.3. Incoming call redirection

Two monitors connected into one system are used.

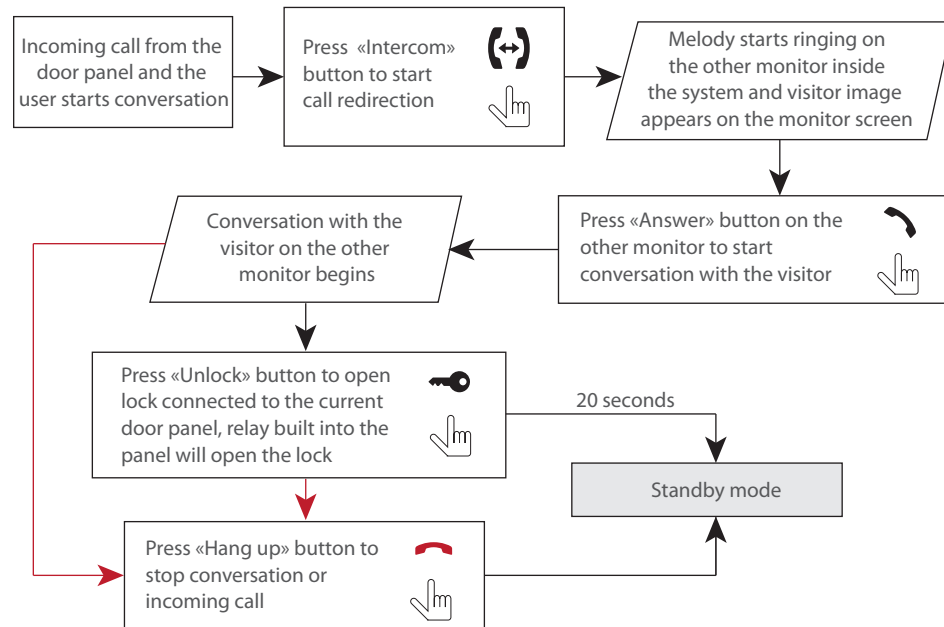

Note:

If incoming call is successfully redirected to the other monitor then current monitor will enter standby mode.

5.4. Intercom

Two monitors connected into one system are used.

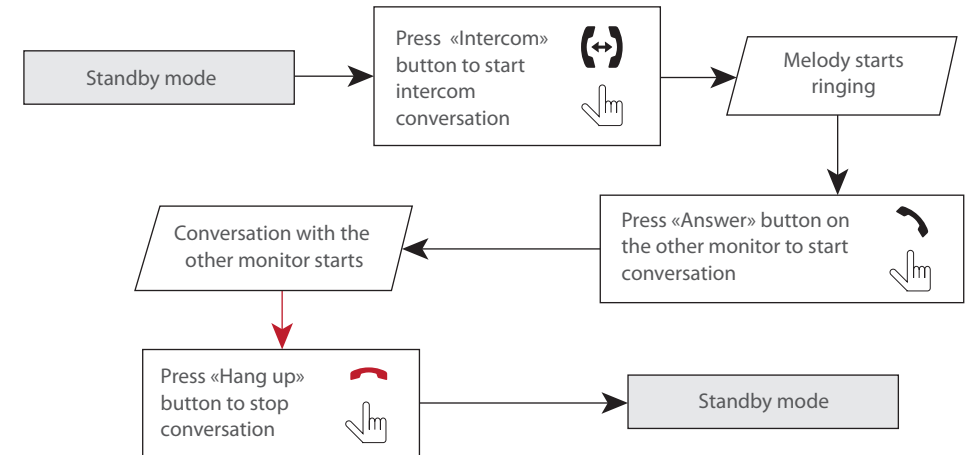





Note:

If somebody press call button on the door panel while intercom is active then the image from the door panel appears on the monitor screen and call melody starts. Press «Answer» button to start conversation with the visitor.

6. Settings

Settings joystick  situated on the right side of the monitor case. It has several functions:

- press the  joystick in standby mode to enter monitor settings;
- move the  joystick up or down to change current parameter of the monitor settings;
- press the  joystick again to choose current parameter and move it up or down to change current parameter value;
- press the  joystick one more time to save current parameter value;
- press the  joystick in monitoring or conversation mode to make a snapshot or start video recording (depending on record settings). Press the joystick again to stop video recording.

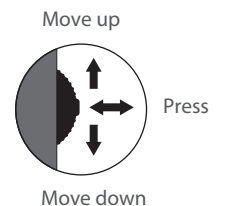

6.1. Main menu

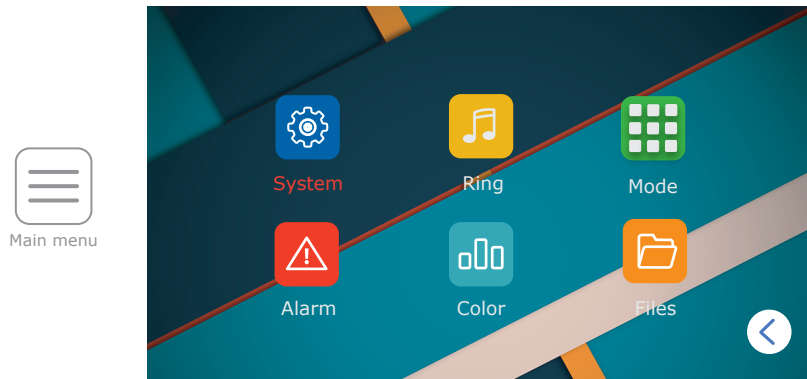

6.2. System settings

Press «System» icon in the main menu to enter monitor system settings:

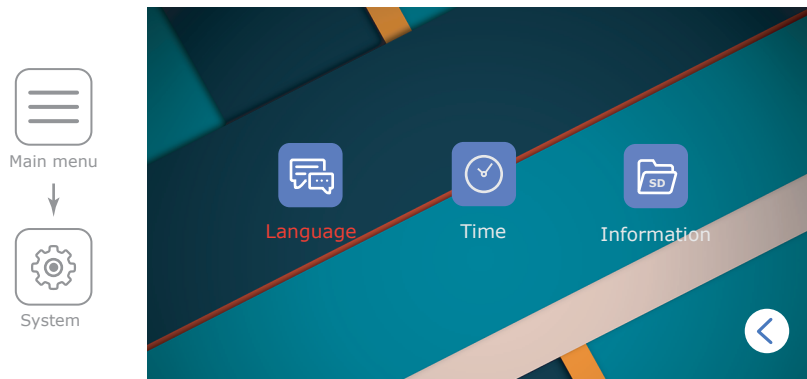

Following parameters are available in the «System» menu:

Language – the language of the settings menu;

Time – date and time settings;

Time display – date and time screensaver display in stndby mode (Off, 1, 3, 5, 10 min.);

Information:

Software version – current software version of the monitor;

Release date – date of software release;

Format SD – micro SD card formatting. Please format microSD card before use it.

Recommended to use microSD cards of the 6-th class and above;

Format flash – internal memory formatting;

Backup pictures– copy files from the internal memory to microSD card;

Update –firmware updating of the monitor (place updating files in the root folder of microSD).

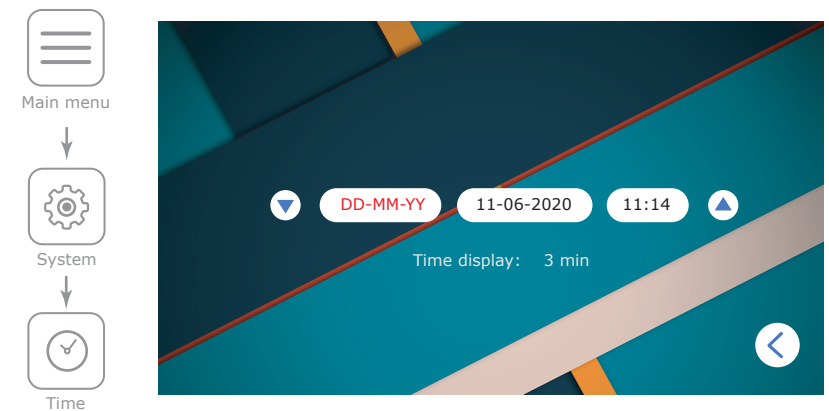
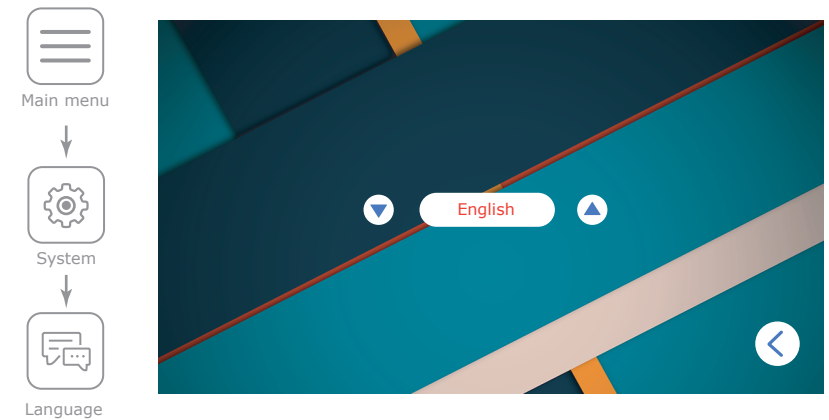

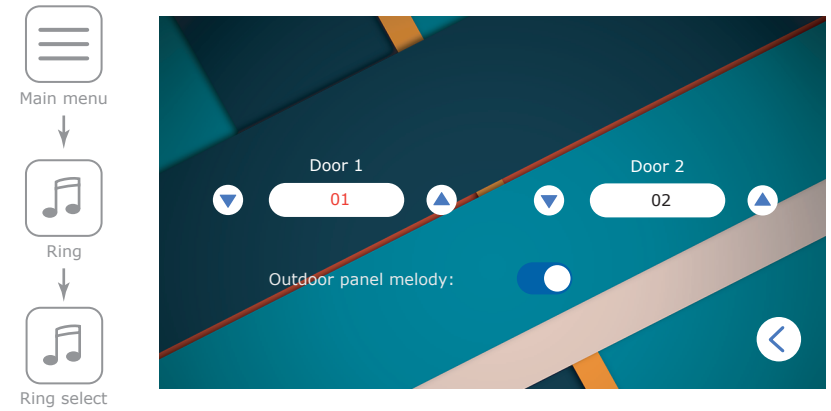
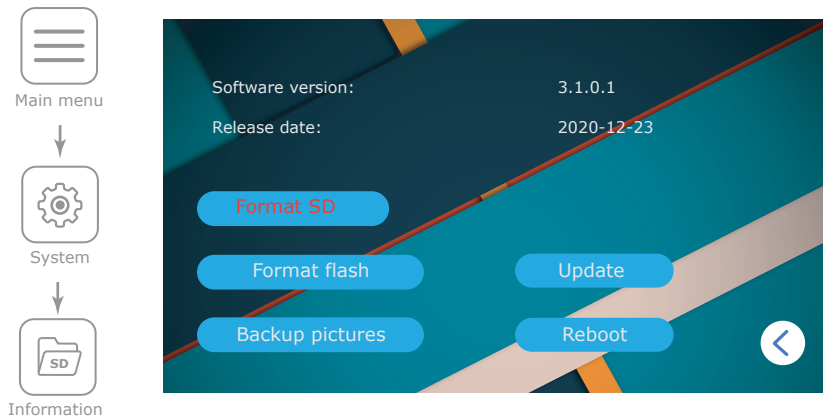

6.3. Ring settings

Press «Ring» icon in the main menu to enter melody and volume settings.

Following parameters are available in the «Ring» menu:

Ring select – choose the melody for every door panel.

Ring volume – choose volume level (from 00 to 09) depending on the time of a day and also ringing time of the melody (10-45 seconds).

Silence mode – incoming call melody and keyboard muting, «On» or «Off».

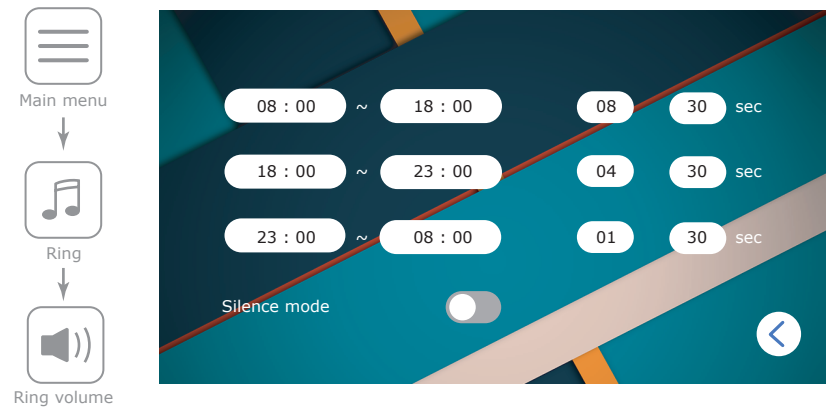

6.4. Working mode settings

Press «Mode» icon in the main menu to enter working mode settings.

Following parameters are available in the «Mode» menu:

Mode – choose «Master» if you use one monitor in the system or if it's the monitor which all the door panels and CCTV cameras are connected to. Choose «Slave» if there is more than one monitor in the system and no door panels or CCTV cameras connected to this monitor;

Door 2 status – «On» or «Off», include or exclude second door panel from the monitoring list;

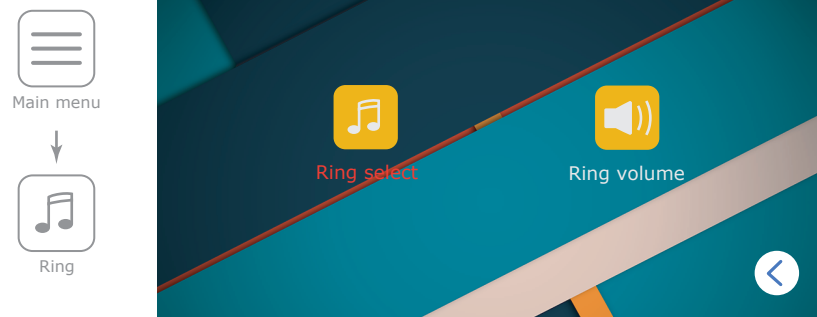

Record mode: «Snapshot» – take snapshot while incoming call or manually;

«Record» – record video while incoming call or manually;

Door 1 unlock time – Door 1 relay delay time, 2 –10 seconds;

Door 2 unlock time – Door 2 relay delay time, 2 –10 seconds;

Key backlight – «On» or «Off»;

Keyboard sound – «On» or «Off».

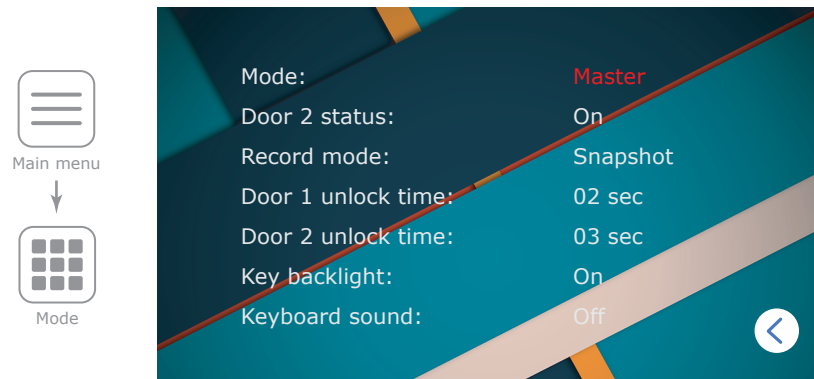

CAM1 – «On» or «Off», include or exclude first CCTV camera from the monitoring list;

CAM2 – «On» or «Off», include or exclude second CCTV camera from the monitoring list;

CAM1 ring time – alarm melody ringing time, activated by CAM1 motion sensor, from 00 to 30 seconds;

CAM2 ring time – alarm melody ringing time, activated by CAM2 motion sensor, from 00 to 30 seconds;

Alarm record: «Snapshot» – save photo if motion detection occurs;

«Record» – save video if motion detection occurs.

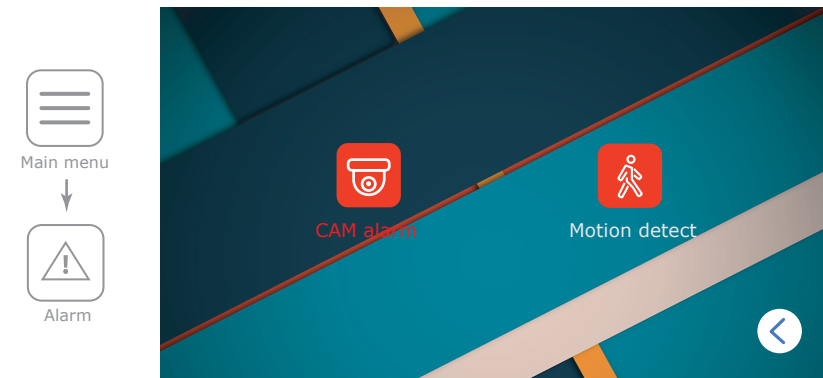

6.5. Alarm settings

Press «Alarm» icon in the main menu to enter alarm settings.

Following parameters are available in the «Alarm» menu:

CAM alarm – additional cameras alarm settings;

Motion detect – software motion detection.

CAM alarm includes next sub menu:

CAM1 sensor type: «NO», motion sensor with normally disconnected contacts are used;

«NC», motion sensor with normally connected contacts are used;

«Off», motion sensor doesn't used;

CAM2 sensor type: «NO», motion sensor with normally disconnected contacts are used;

«NC», motion sensor with normally connected contacts are used;

«Off», motion sensor doesn't used;

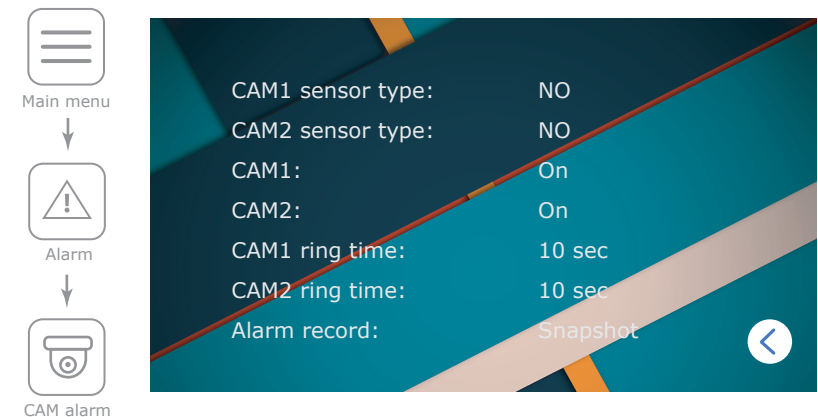

Software motion detector can observe and detect motion without any external sensors using any camera image changes with the time. Camera power that is used for motion detection should be constantly on to let the monitor observe image changes and detect it.

Motion detect includes next sub menu:

Motion detect source: «Off» – software detector is off;

«Door 1» – motion detection on Door1;

«Door 2» – motion detection on Door2;

«CAM 1» – motion detection on CAM1;

«CAM 2» – motion detection on CAM2;

Motion detect area – set image area which motion detection is performed;

Store mode: «Snapshot» – save photo if software motion detection occurs;

«Record» – save video if software motion detection occurs;

Notification – «On» or «Off». Enable or disable visual notification if software motion detection occurs.

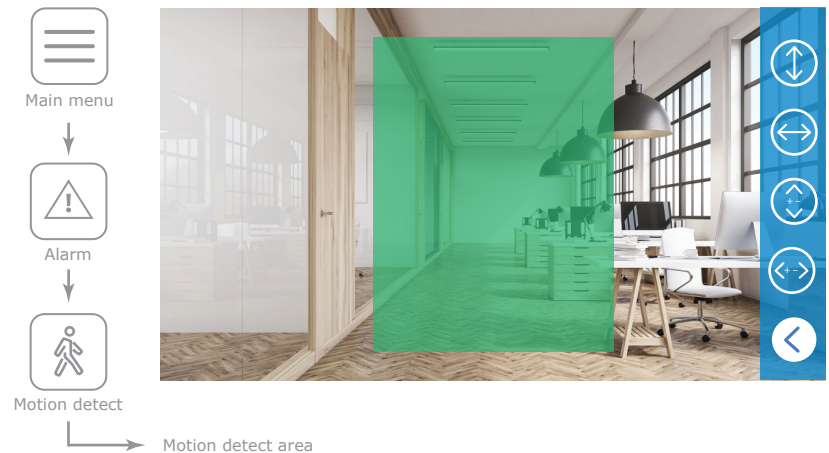
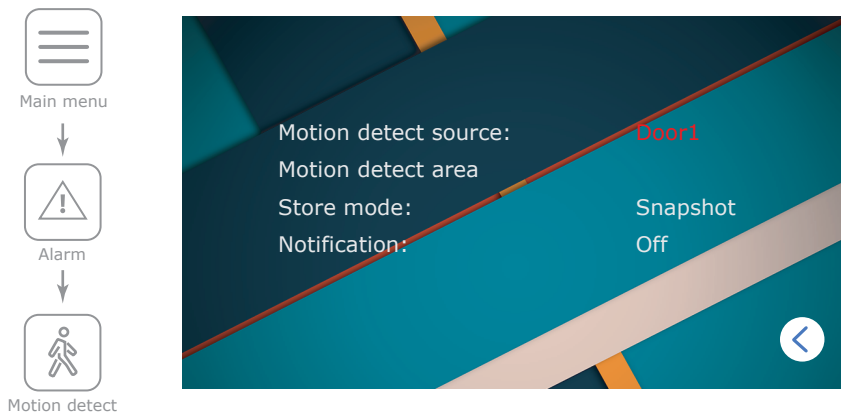

6.6. Image parameters setting

Press «Color» icon in the main menu to enter display settings.

Following parameters are available in the «Color» menu:

Door 1 – image settings for the first door panel;

Door 2 – image settings for the second door panel;

CAM 1 – image settings for the first CCTV camera;

CAM 2 – image settings for the second CCTV camera.

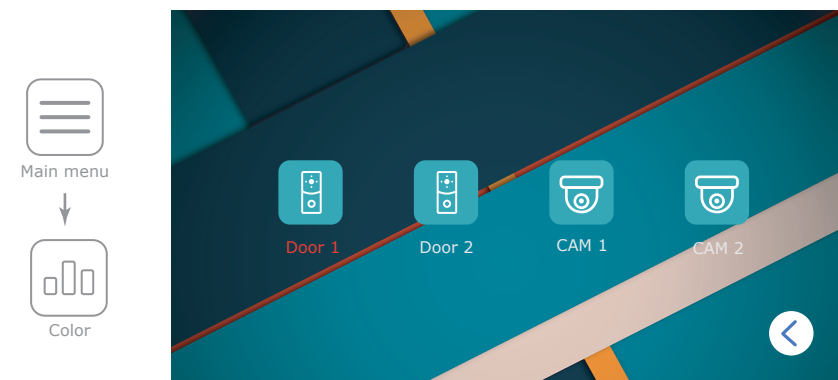

Every video source has its own image settings:

Brightness – parameter range from 0 to 50, 25 used by default;

Contrast – parameter range from 0 to 50, 25 used by default;

Color – parameter range from 0 to 50, 25 used by default.

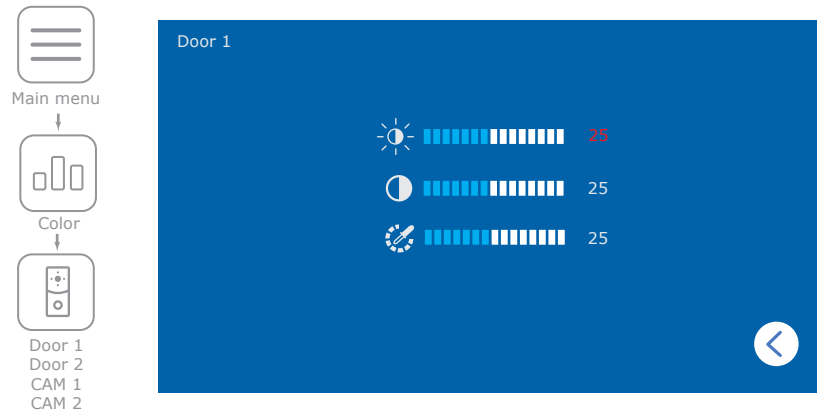

6.7. Snapshots and records playback

Press «Files» icon in the main menu to enter snapshots and records playback.

Following parameters are available in the «Files» menu:

Record files – records playback;

Snapshot files – snapshots playback.

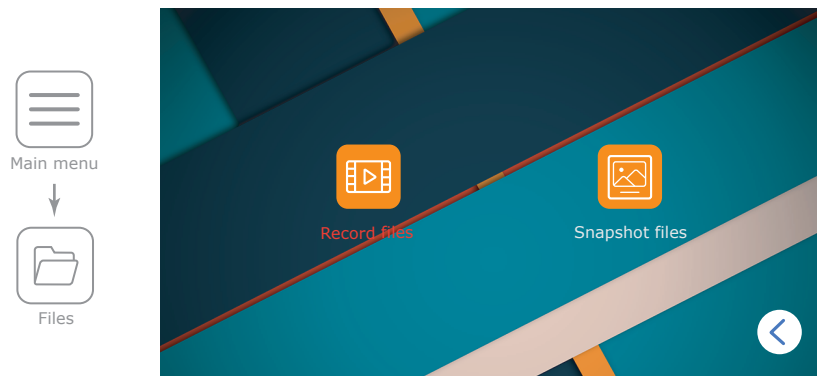

Press «Record files» or «Snapshot files» icon to enter snapshots or records playback menu then choose the file to play by moving joystick up or down. Press the joystick on the file to open side menu.

Choose one of three operations:

Play – current file playing;

Delete current file – current file deleting;



Delete all file – all files deleting.

Choose the desired action by moving joystick up or down, then press the joystick to perform this action. While playing press joystick again to get back to the file list.



7. Manual and automatic recording

User can take manual snapshots or record video during monitoring outdoor panel or CCTV camera.

Press  joystick on the right side of the monitor to start manual recording then press  joystick again to stop recording (if video recording mode is active in «Main menu» → «Mode» → «Record mode» setting, page 17).

Press  joystick on the right side of the monitor to take a snapshot (if snapshot recording mode is active in «Main menu» → «Mode» → «Record mode» setting, page 17).

Automatic recording occurs every time anybody presses call button on the outdoor panel or some kind of motion detection is enabled and triggered.

Note: video can be recorded only if microSD card is installed into the monitor's slot. In case there is no space on the microSD card then new records will replace old one.

8. Hardware motion detection recording

Camera 1 and Camera 2 have motion detection function by external motion sensor signal. When external sensor connects or disconnects its contacts (depending on «Sensor type» setting of CAM 1 or CAM2 in «Main menu» → «Alarm», page 17-18), recording starts on the monitor. Video recording time is 10 seconds. Press  button to stop recording manually.

Use any external sensors that have normally opened «NO» or normally closed «NC» contacts. When the sensor is activated it connects (NO case) or disconnects (NC case) contacts, that triggers recording on the monitor.

External motion sensor connection.

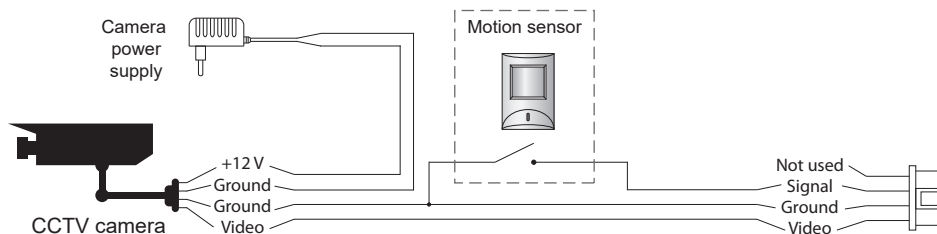

9. Limited warranty

Manufacturer guarantees product normal functioning during the warranty period if the user keeps all safety instructions described in that manual.

Warranty period is 12 months from the moment of the product purchasing (warranty period could be extended up to 24 months or more, depending on the local regulations).

Warranty period allows user to make guarantee repair in cases when normal functioning of the product was violated by the fault of manufacturer and the user has not offend transporting, installation and working conditions.

This limited warranty does not cover any damage to the product that results from improper installation, accident, abuse, misuse, natural disaster, insufficient or excessive electrical supply, abnormal mechanical or environmental conditions, or any unauthorized disassembly, repair or modification.

Warranty void in such cases:

- the product was damaged by the fault of the customer;
- the product wasn't properly installed according recommendations from the manual;
- the sticker on the backside of the product was broken;
- the product was not used for its intended function.

This limited warranty covers only repair, replacement, refund or credit for defective products, as provided above. Manufacturer is not liable for, and does not cover under warranty, any damages or losses of any kind whatsoever resulting from loss of, damage to, or corruption of, content or data or any costs associated with determining the source of system problems or removing, servicing or installing products. This warranty excludes third party software, connected equipment or stored data. Manufacturer is therefore not liable for any losses or damage attributable to third party software, connected equipment or stored data.

In the event a product has been discontinued, manufacturer shall either repair the product, offer to replace it with a comparable product or provide a refund at the lesser of the purchase price or the product's current value.

Repaired or replacement products will continue to be covered by this limited warranty for the remainder of the original warranty term.